

Quantum Source Book

Getting the best
from your system

Quantum Theory	
Introduction	2
The Quantum Products	2
What is Quantum... And why is it different?	3
Okay – So How Does It Work?	4
Results You Can See – Measuring Quantum	5
Using Quantum	
Building A Foundation	6
Good Housekeeping	7
Your First Qx Unit	8
Adding More Quantum Units	9
Taking It To Extremes	10
Q&A	11
Awards And Reviews	13

www.quantumqrt.com

Introduction



Quantum Resonant Technology manufactures a range of AC mains related products that are very, very different to the norm. Our modular approach is based on unique technology that has never previously been applied to the world of hi-fi. As a result, certain bits of received “wisdom” that are currently fashionable don’t apply to getting the best out of QRT products, while older, fundamental lessons, learnt the hard way a long time ago and since forgotten, do apply – with a vengeance.

This Quantum Source Book sets out to show you how to get the best results, not just from QRT products, but from any system and its AC supply. Follow its simple, clear logic and we think you’ll be surprised by the musical results – even before you add the benefits of Quantum. After all, there’s little point in rinsing a glass with fine wine when its inside is still smeared with dishwasher detergent...



© 2009 Quantum QRT. All rights reserved



Quantum QBASE QB4



Quantum QBASE QB8



Quantum QRT Qx2



Quantum QRT Qx4

So What Is Quantum...

And why is it different?



Whilst mains quality has always been somewhere on the hi-fi radar, over the years many of the more conventional attempts to do something about it have ended up doing more harm than good. But in our current, data intensive and wireless world, with mains born pollution increasing at an alarming rate and to unprecedented levels, the hi-fi industry has started to take the issue seriously again. Unfortunately, what that generally means is refining or revising the established approaches, reducing but not eliminating their side effects.

Quantum Resonant Technology has developed an entirely new approach to improving mains quality and system performance. Based on research into Quantum Field Theory (QFT), the fundamental basis of Quantum Mechanics, it is a non-intrusive, field based approach to system treatment. As such, it doesn't sit in the AC power line and crucially, leaves both source impedance and peak current capabilities unaffected. Instead it acts to order and reduce the impact of stray electro magnetic energy within the AC power loom and the equipment it supplies, effectively making the system's job easier

by giving it less pollution and residual interference to deal with.

Because it is a field based technology, both the placement and power of the field will affect performance, making this one power supply element that you want to place right at the heart of your system. This also means that by its very nature, Quantum field technology benefits from both reinforcement and spaced arrays to spread its impact. It is this that makes it modular by tendency – and Quantum products modular in nature.

So, in a world where we are becoming increasingly used to rapid technological redundancy, Quantum units can be stacked for ever greater performance benefits, meaning that you never have to abandon or trade one in when a newer, bigger or better version comes along: partly because, at QRT we are the only people who use this unique approach and partly because the units are completely complementary in performance. Also, simply because Quantum is unique, its benefits can be added to any existing system, irrespective of type or price. The better the system, the greater the benefits, because what Quantum does is let you hear the way your system really sounds...



Okay, So How Does It Work?

Or, trying to distil the collected advances of 20th Century physics into 250 words!



Well, we might say that it uses an array of scalar field generators to impact the system's operating parameters, by functioning at the beat frequency of its electromagnetic energy. Which sounds really impressive, but does it actually mean anything?

And therein lies the rub. Most of us are familiar with basic, classical physics – the likes of Newton, Boyle and Flemming. The trouble is, things have moved on – and we haven't. So, whilst we've heard of Einstein, Schroedinger, Planck and Dirac, not a lot of us actually really understand the detail or significance of what they said – probably because they were all geniuses and most of us aren't. Which means that, unless you happen to have studied Quantum Mechanics, understanding how exactly the QRT units work probably isn't on the cards.

Now, that sounds like a cop-out based on some sort of sci-fi script, so let's actually look at the real world instead. Quantum Mechanics is what scientists are studying with the LHC

in Cerne, a massive project that wouldn't have happened unless it promised some very practical results. Results like the laser, the electron microscope and the MRI scanner, all of which are based on Quantum theory. You want more real than that? How about the transistor? All those solid-state devices and chips are a direct result of the practical application of Quantum Field Theory, an interesting example because, although we all know that transistors and microchips work, how many of us actually know how? I mean really understand, on a sub-atomic level. Unfortunately, it's not a technology that can be explained by the classical physics that most of us are familiar with. But we know that transistors work because we have experienced the fact; and we don't let our ignorance of their theoretical minutiae prevent us from enjoying the benefits.

Which brings us back to QRT. Rather than try and explain how it works, isn't it easier to simply show you that it does? After all, why forego the benefits just because you can't follow the process...



Newtonian physics

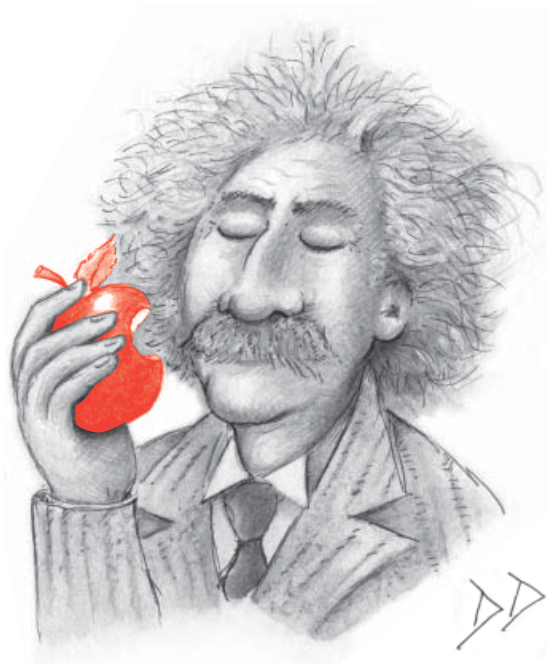

Quantum physics

Results You Can See...

Independent measurements of the Quantum Effect



In order to demonstrate the measured effectiveness of Quantum technology, we engaged the services of Acuity Products, a UK based, independent defence contractor, who specialize in the assessment and signal intelligibility. They have extensive experience in the development and testing of sonar, radar, ECM and signal processing algorithms, fields that attract, and demand the most sophisticated approaches and technology available. They devised a range of measurement protocols specifically to investigate the impact of QRT units (and other devices) on hi-fi system performance. These are outlined in much more detail on the Quantum website (www.quantumqrt.com) but let's look at the simplest example.

First, they analysed a passage of music from a CD, creating a graphical representation of signal over time. Then, using a well-regarded CD player (with a retail cost of around £4000) they measured and analysed its output whilst playing the same passage. Comparing the output with the original signal revealed errors typically in the region of 10%! And this is supposed to be high-fidelity? What is more, this is not particularly unusual. The player wasn't chosen for its poor performance, or any particular technology, such as a valve output stage. In fact, in most conventional senses, it could be said to have an exemplary measured performance.

Now plug the same player into a Quantum Qx4 and play the test track. The result is a reduction in total error of a little over 5% – or a 50% reduction in the error value!

Not bad from one QRT unit feeding just a CD player. Look at the additional information on the website and you'll see that this is only the start. Further tests reveal not just how big the differences are, but what is actually going on within the signal – or, why the effects of Quantum technology sound the way they do. Now, consider that the Qx4 is a field generator that will affect every unit in the system! More equipment, more effect. Of course, these protocols have also been applied to cables, supports and power cords – all the things that the “scientists” and their measurements tell us don't make a difference. And guess what? The differences really are just as huge as they sound, just as apparent as they are audible.

Which begs the questions: What exactly have these people been measuring? And isn't it about time they woke up to reality and embraced the concept of relevance? Acuity have already produced results that clearly reflect and correlate with what we hear. But the best bit of all is that, whilst it's lovely to have your experiences confirmed, the measurements really are only agreeing with what your ears have already told you.

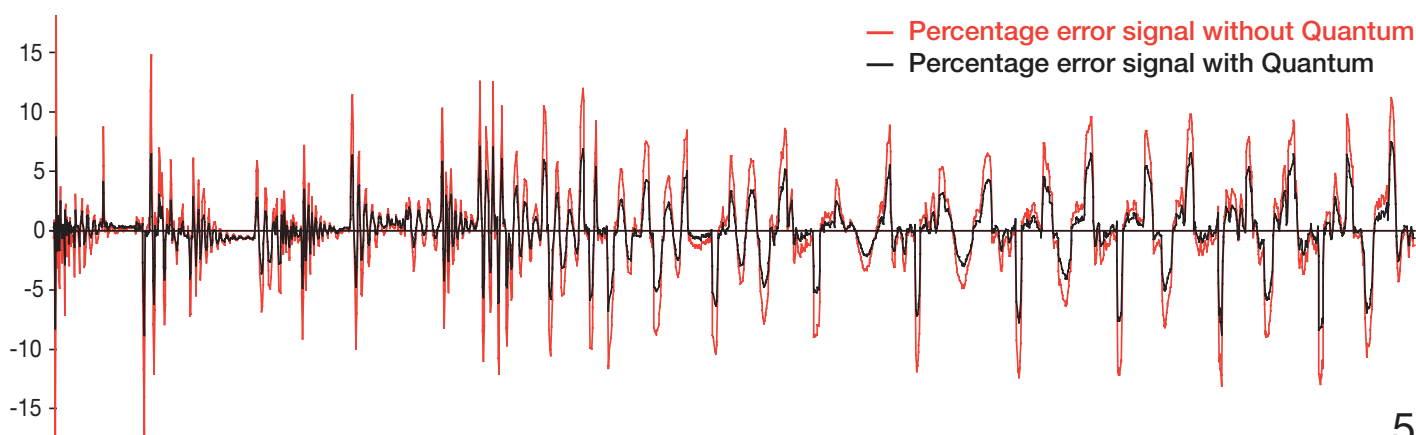

Using Quantum...

First, build a solid foundation



Whilst QRT's Qx2 and Qx4 are the company's higher profile products, don't overlook the fundamental importance of the high-quality AC distribution solution delivered by the Quantum Powerstrips. There's more to these apparently simple multi-socket devices than meets the eye and despite the absence of "active" circuitry, they are the basic building block on which you should base your hi-fi system's AC mains supply.

Inside each Powerstrip is a carefully engineered, star-earthed circuit board, its layout and dimensions specifically selected to operate in conjunction with the high-quality machined and extruded alloy casework to minimize the impact of mechanical energy transported by the mains. The circuit tracks are also linked to an earth socket,

allowing the use of a separate, dedicated system ground, a simple and cost effective addition to any hi-fi installation which leads to a significant reduction in sonic pollution. Connect a clean ground to your system and you'll hear an obvious drop in noise floor, with blacker backgrounds, less grain and more vibrant instrumental and tonal colours.

But even with star-earthing and a clean ground, the order in which you connect your system will still make a difference. Equipment should be hooked up in system order, priority source first, then the main signal path and finally, ancillary sources. This will produce the best and most coherent results from your most important source material.

Which brings us to...

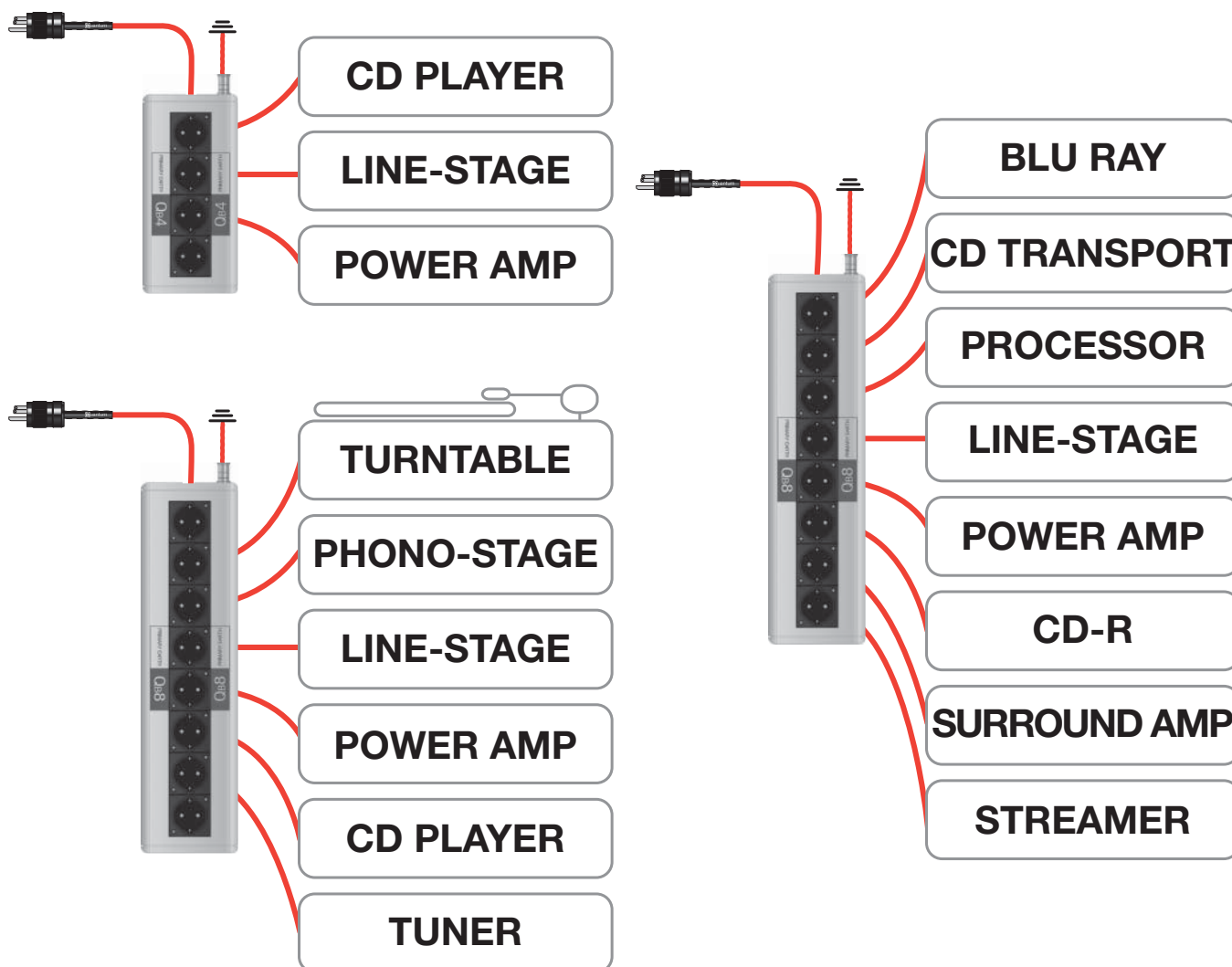

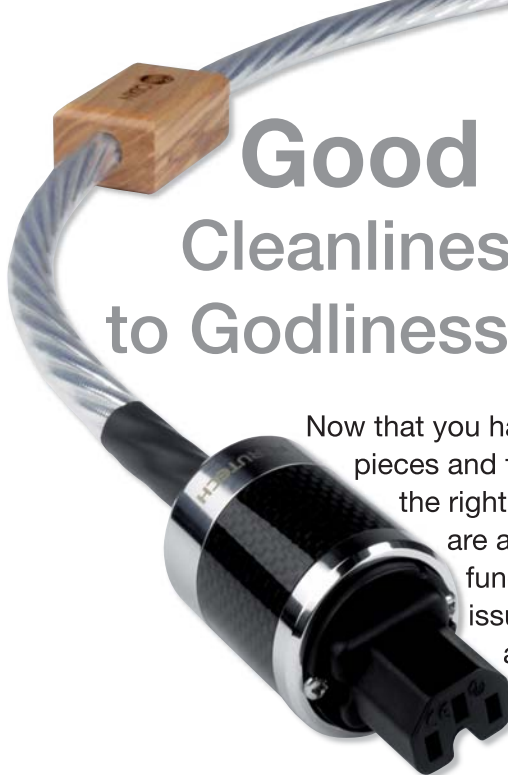

Good Housekeeping... Cleanliness (and order) is next to Godliness



Now that you have the right pieces and they're in the right place, there are a few other, fundamental issues to address:

☐ Power Cords – ideally these should be identical throughout the system, or at least from the same source and using the same materials and technology. If they do come from a single company but vary in quality, then the best one should be used to connect the distribution block to the wall, with subsequent priority being integrated amplifier or power amp, then pre-amp, then primary source.

☐ Bear in mind that the different mains sockets sound different. The best are the US or European Schuko types. There is nothing to stop you using these within your system, or even on a dedicated AC line.

☐ Using a commercially available cleaner such as Deoxit, first switch off the household supply and then clean all the plugs and sockets in the system's AC supply chain. Clean and tighten all internal connections. If you are using UK type 13A plugs, don't forget to clean the fuses – or better still, replace them



with an audiophile type, such as the extremely cost effective DCT fuses from Russ Andrews (www.russandrews.com).

☐ Check the mains polarity of each unit in your system – especially simple with Schuko plugs that can simply be reversed. If in doubt, use an Elfix detector, again available from Russ Andrews.



☐ Cable dressing – as you reinstall your power cords, keep a healthy distance between them and your signal leads. Where they must cross, make sure they do so at right angles.

☐ Use a system de-mag disc and Eco3 static inhibitor.

☐ Equipment support is more important than you think. Make sure that each shelf of your rack(s) is perfectly level – and we do mean perfectly. A precision spirit level is essential to this task and represents an upgrade all on its own. And it's not just turntables and CD players that need to be level: all equipment benefits to a greater or lesser extent. Finally, having got everything level (and stable) make sure that it stays that way by securing the locknuts on the levelling feet. Then check the level one more time...



Once, and only once you have paid attention to these aspects of system performance will you be hearing your hi-fi equipment sounding as good as it can. Now, when you start to add Quantum field devices, the effects will be even greater and more obvious. QRT might deliver more from the system you already own, but it delivers more still if that system is already working well.

Your First Qx Unit...

Its place in the wiring loom, its place in your system



Once you have a properly configured and optimized AC supply for your hi-fi system, it's time to add a Quantum Qx2 or Qx4. This should be placed between the wall socket and your Powerstrip or other distribution device (such as a Nordost Thor) connected, as noted above, with an identical or even better quality power cord. However, remember to maintain the coherence of your cable loom and don't be tempted to use a notionally superior or more expensive product from a different source to the rest of your cables in this critical location.

You can of course, place the Qx unit to one side of the system, using it to physically link the equipment to the AC supply and keep cable lengths (and costs) to a minimum. But, as appealing as this might be, remember

that the Quantum units are field generation devices, and that they'll work best placed as close as possible to the heart of your system. The heavy aluminium side panels on the Qx casework are designed to focus the field up and down, so ideally you should provide the Qx unit with its own shelf in the middle of your main system rack. If your rack is already full and you cannot (or don't wish to) add another shelf, take this opportunity to remove whichever piece of equipment generates the greatest degree of mechanical noise to a separate location. This is generally either the power amp(s) or the unit containing the largest power supply. Not only will this isolate the system from this intrusive source of interference, it also allows you to ensure a proper support solution for the item in question.

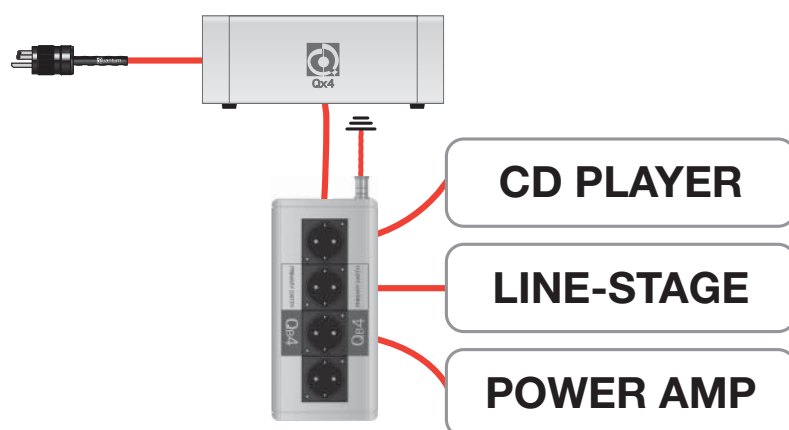

Adding More Quantum Units...

Once you get used to the benefits, one will never be enough!



Having heard what a single, properly deployed Qx unit can do, especially in a well-sorted system, it's going to be hard to resist the temptation to add additional units – just to see what happens. The answer is, it just goes on getting better. But carefully arranged, the effects of Quantum technology can produce results that are even greater than the sum of the parts. Thus, whilst the more Quantum you have, the better it is, making sure that it is positioned properly, both in the AC supply chain and within the system itself, will reap additional benefits.

With a second Qx, normally this would be connected between the Powerstrip and your integrated or pre-amplifier. But, another way of looking at this is in terms of equipment quality: if your system contains a star performer, one piece that stands above everything else, then that is also a good place to deploy your second Quantum. In other words, go for the quality!

Again, it should be physically placed at the heart of the system, but spaced slightly from the other Qx unit – either side by side or one top and one bottom of the rack. Done properly with a Qx4 feeding the distribution unit and a Qx2 placed after it, you'll be surprised just how effective the smaller unit is, the presence of the Qx4 seemingly increasing its power. In fact,

you could be forgiven for thinking you'd added a second Qx4 to the system.

When it comes to adding a third unit, connect it between the distribution unit and either the power amp or the most critical source component. You can expect the same elevated level of performance, but the placement should be rather different. If the second unit was placed on the same level as the first, the third one should be positioned lower down. If the second one has already been placed in the lower position, then spread the placement of the third laterally.

Does that mean that once you have a Qx4, you should only add Qx2s? In fact, multiple Qx4s are even more effective, but the beauty of this situation is that it means that you can start with a Qx2, safe in the knowledge that it won't become redundant. Indeed, quite the opposite...

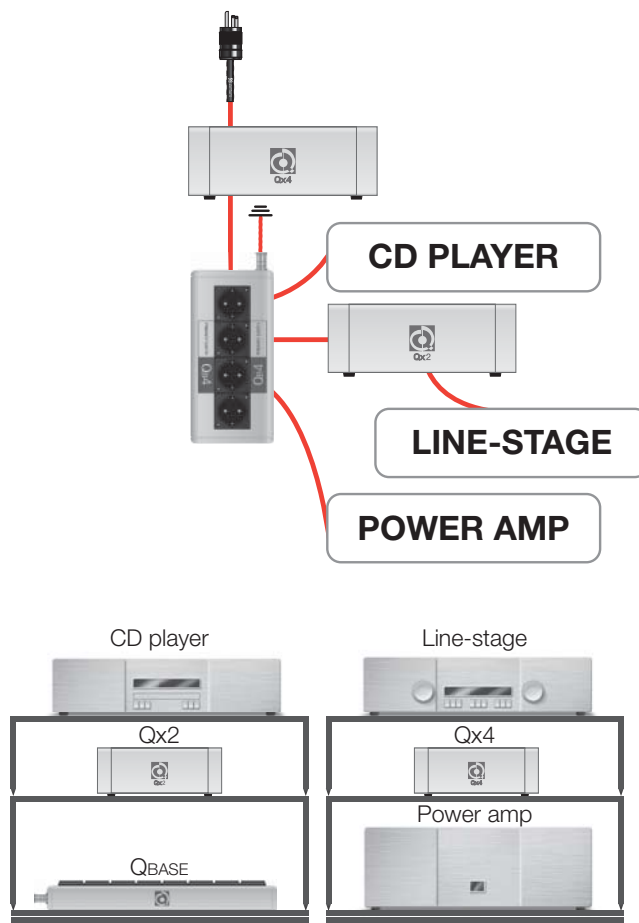
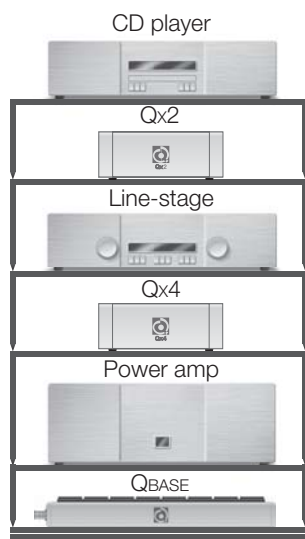

Taking It To Extremes...

The full Quantum fix



Given the addictive nature of Quantum's musical effect, there will be those who want to take it to its logical extreme, extracting every last ounce of performance from their system. We've done it and the results are stunning.

Assuming that you won't be doing this in a single step, how should you set about it? Once you've got at least three Qx units working with the main system, the next step is the speakers. Speakers? Oh yes. Just think of the magnetic fields inside those drivers; just think how large the crossover components are. And with hybrid speaker designs employing active bass (not to mention electrostatics) the possibilities are even greater. With speakers, the Quantum units (Qx2s for compact stand mounts,

otherwise Qx4s) should be placed directly behind the most powerful magnetic structure, normally – but not always – the bass driver; you might need a stand to achieve this. With electrostatics, the units should go centrally at the bottom of the driver, and with hybrids, between the bass driver and the electronics package or the midrange panel, depending on type. And don't forget sub-woofers, where a Qx unit placed on top of the cabinet can have a dramatic effect that, just like the sub itself, affects the entire musical range.

After that, concentrate on adding a dedicated Quantum unit to each item in the system (they are especially effective with turntables) and a second Qx4 between the wall socket and the Powerstrip. You can also use this as an opportunity to optimize the lengths of the compound cable feeding each unit. Shorter isn't always better, especially when it comes to the lead between the wall and the system, and further gains can be made here, with any Nordost Reference dealer able to advise you on this.

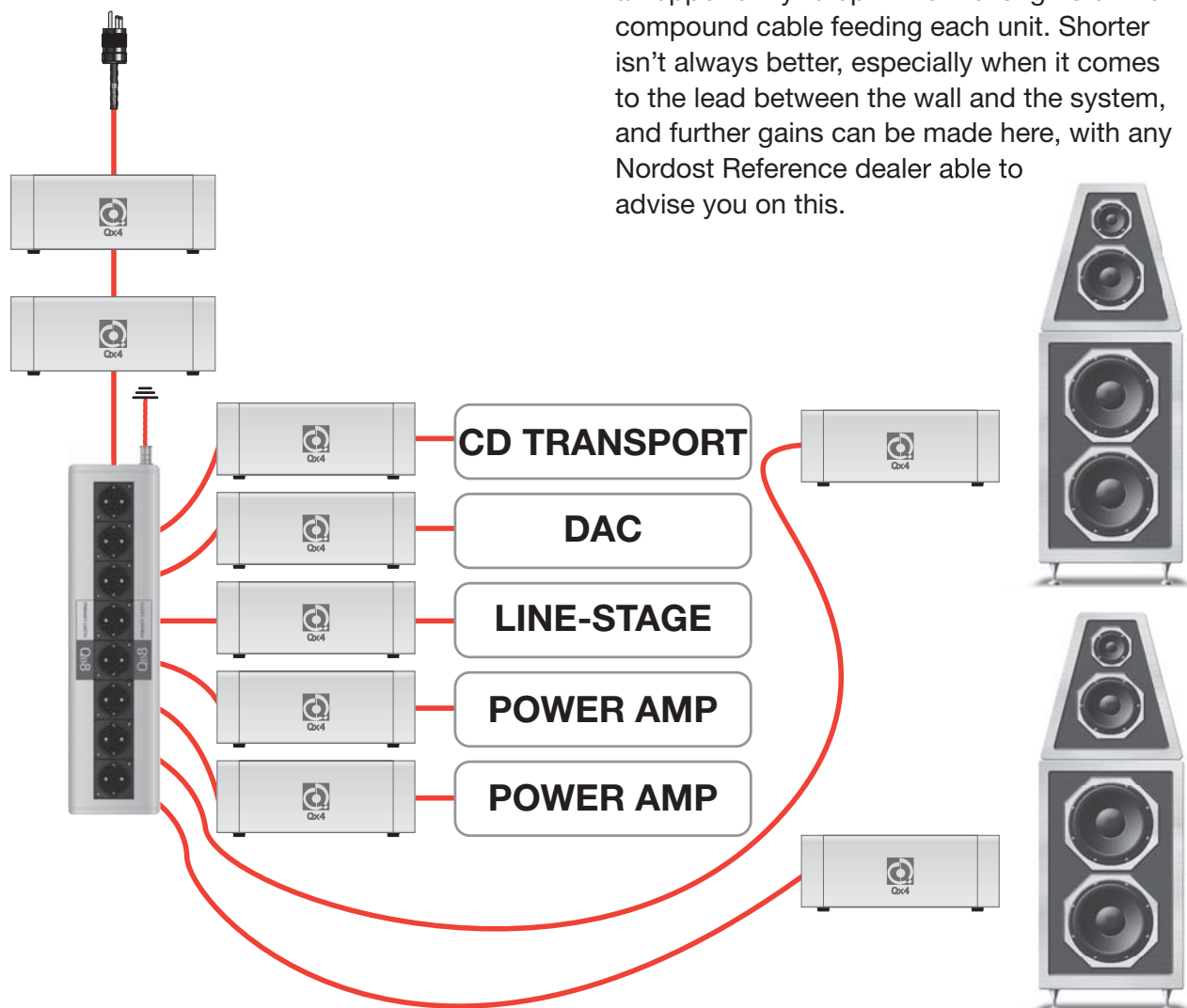



Q. Can I add Quantum Qx units to any system?

A. The short answer is, yes. We have not discovered any audio or video equipment or technology that doesn't benefit from Quantum. Adding QRT to any system should make a readily appreciable difference, generally a significant improvement in clarity, musical flow, communication and timing. The sound should be more immediate and more obviously present, especially with live recordings.

However, in rare instances, Quantum will either have a negative effect, or rarer still, no appreciable effect at all. Far from being a case of Quantum not working, this is an example of exactly how it works. Think of QRT as a system clarifier, a window on the way your system is working. If it's working well, that will be all the more apparent. But, if there are underlying problems these will also become more obvious. So, if adding a Qx2 or Qx4 to your system makes it sound worse, go back and check the basic set up and housekeeping details outlined on pages 10 to 13; If those don't put things right then look at compatibility within the system itself.

If Quantum makes no apparent difference then it suggests that you have already reached the resolution floor and dynamic limits of your system. This can be a result of over complexity, especially in larger systems. Try substituting an integrated amp for a large pre-power combination, an integrated CD player for a multi-box set up with a separate processor. Now see if the Qx unit makes a difference. If it does, the integrated units will probably have sacrificed a small amount of detail or control, but you'll likely have gained considerable musical communication.

In either case, the QRT unit is simply telling you far more clearly what is (or isn't!) happening in your system. You can choose to

act on what it tells you – or you can shoot the messenger. Just remember; there are no magic bullets in hi-fi.

Q. Is there such a thing as too much Quantum?

A. Again, the short answer is, no. There may be a point where you reach saturation, but we've yet to discover it – and we've tried! However, layering effects from using multiple Qx units can be cumulative, adding significantly to the overall benefit. So, no matter how many QRT units you are using, still take care over their placement and connection.

Q. Can I mix Qx2 and Qx4 units?

A. Yes you can. See page 16 of this guide and you'll see that there's actually an argument for doing exactly that.

Q. I've tried mains filters before and they destroyed my system's dynamics. Won't Quantum do the same thing?

A. Conventional mains filters and regeneration devices all have associated side effects, and although modern units have less impact on voltage swing and source impedance, generally heard as a reduction in absolute dynamic range (although they also reduce the edge and glare that make peaks sound louder) their thumb print can still be heard.

QRT's unique approach works on minimizing the deleterious impact that accompanies all forms of AC and DC power. It does not effect voltage swing or source impedance and will not limit system dynamics. In fact, measurements show that it consistently increases both dynamic range and peak level. What's more, whilst the field effects generated by the incoming power supply are greatest at mains potential, parasitic fields



will also be created throughout your equipment's circuitry and as a field generator, Quantum works on these too, meaning that its benefits extend way beyond just the AC mains supply.

Q. What about AV systems? Does Quantum work with pictures?

A. Absolutely. In fact, Quantum is one of the most cost effective upgrades you can make to display quality, improving colour saturation, dimensionality, separation and perceived depth. But be warned. Once you've watched a video display connected up with Quantum, you won't want to be without it...

Q. Can I upgrade a Qx2 to a Qx4?

A. There is no upgrade available from the Qx2 to the Qx4. Because Quantum is a modular approach to mains quality, any unit you purchase will never become redundant. If you start with a Qx2 and later add a Qx4, then the Qx2 will simply move further down the system, becoming a dedicated feed for a single unit while the Qx4 takes over the AC line as a whole.

Q. If the Qx units are field generators, why do I have to run the AC mains through them?

A. You don't, and the Quantum units still have an effect if they are simply connected to the mains and placed within the system. But, as the greatest source of destructive energy, running the main AC feed through a Quantum unit guarantees the maximum impact in the most critical place. As you add more Quantum units there will be instances where power simply runs into them but not out again, for instance, when placing them close to speakers. But in the first instance (and probably, in the second, third and fourth too) it is always worth running the mains power for

your system or individual equipment through the Qx unit(s).

Q. Do the Powerstrips contain the same field generation technology as the Qx2 and Qx4?

A. No they don't. The Powerstrips are designed to provide a high-quality distribution solution as part of the quantum modular approach to AC mains quality. As such, they represent a fundamental first step in the process of building a proper AC supply for your system. Building QRT circuitry into them would have increased their cost to the point where they were more of an obstacle than a stepping-stone. Instead, Quantum has applied sophisticated mechanical and resonant modelling to their design, enabling them to carry out their apparently simple task in a decidedly superior fashion, a mechanical adjunct to the electro magnetic approach adopted by the Qx2 and Qx4. Like most things in hi-fi, there's a lot more to mains distribution than meets the eye, but listen to the Quantum Powerstrips and you'll be surprised just how audible their "intelligent design" is to the ear.

Q. This is all very well, but isn't mains quality just the icing on the cake of system performance?

A. On the contrary, nothing is more fundamental or basic to the way your system sounds than the quality of the AC mains supply it receives. After all, in a very real sense, the sound you listen to is just the mains chopped up and redeployed, so whether you like it or not, it's the mains you are listening to. Which means that, ultimately, just like a chef preparing fancy food, your system can only work with the quality of the ingredients it has to hand. The better the raw materials the better the end results – only in the case of your hi-fi, the only ingredient is what comes out of the wall.

Reviews and Awards



Our previous Symphony model received widespread critical acclaim from commentators and customers alike. But the Qx2 and Qx4 are significantly refined and far more powerful devices that extend both the effect and possibilities for Quantum technology. Already, reviewers are being bowled over by the results.

Hi-Fi+ Magazine detailed two writers to review our latest Quantum technology:

Chris Thomas found the sonic effects, *“...not subtle at all. Musical phrases are more succinct and also more understandable due to the noticeably enhanced contrast and micro-dynamics... There is no sign of any compressive limiting (with) resolving power and freedom when it comes to those small dynamic variations noticeably improved.”*

His conclusion? *“More Quantum, more music; it really is that simple.”*

Meanwhile, **Steve Dickinson** discovered that, removing Quantum from his system left him feeling, *“...bereft – and I’m not overstating or exaggerating the effect... Quantum technology allows your system to work better, allows it to deliver much more music – and does so in a way that seems unique.”*

Together they awarded the coveted Hi-Fi+ Product Of The Year award.



Meanwhile, **Adam Goldfine**, writing about his experience with the Qx2 and Qx4 in Issue 42 of Positive Feedback, found that the, *“...audible difference was undeniable and anything but subtle... The Quantum units do what they claim with no downside.”*

You can find the full text of these reviews on our website, but listen to a Quantum unit and you too will hear just what got these writers so excited...